

INSYGNÖ

ENEVI



ISO

VSO TSO VSH

IGO

VGO VGH

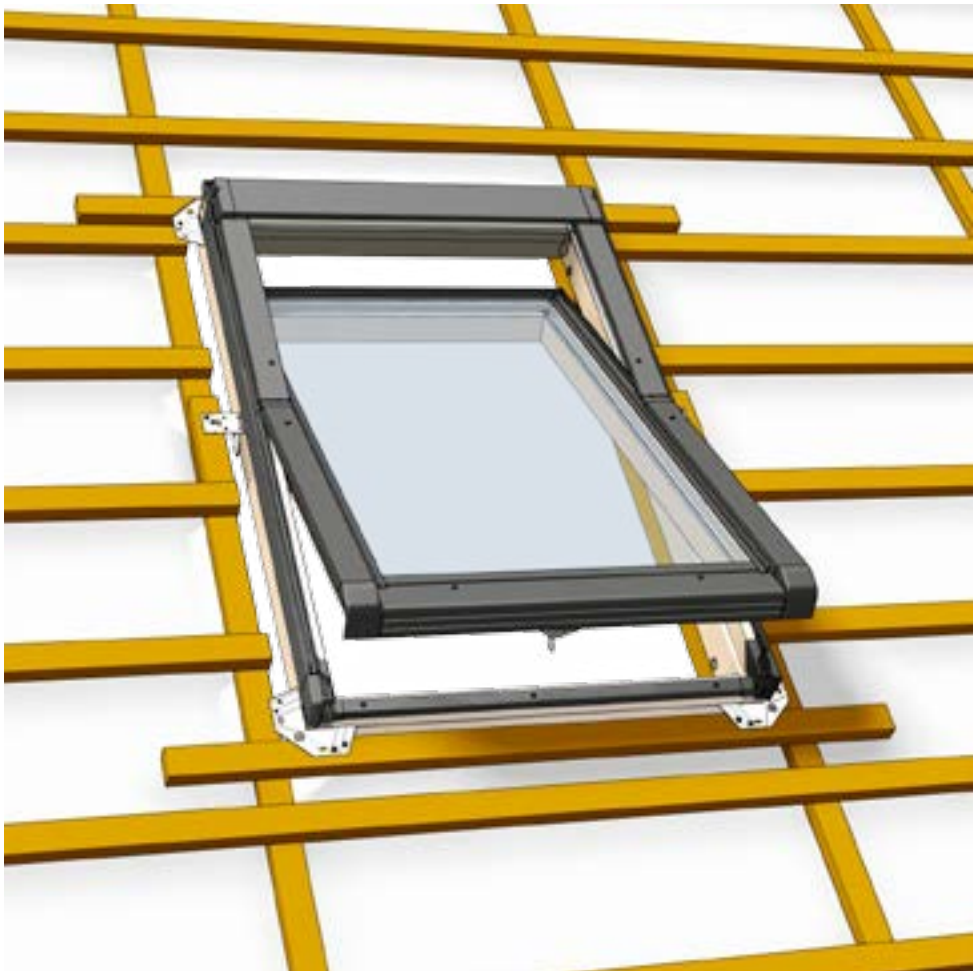

ISO
VSO
TSO
VGO

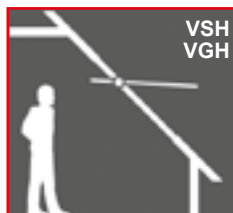

VSH
VGH

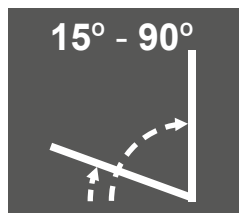

15° - 90°

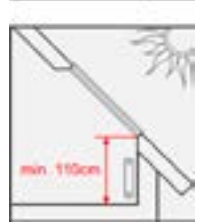
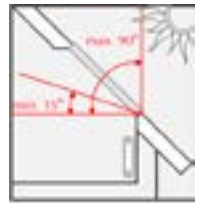
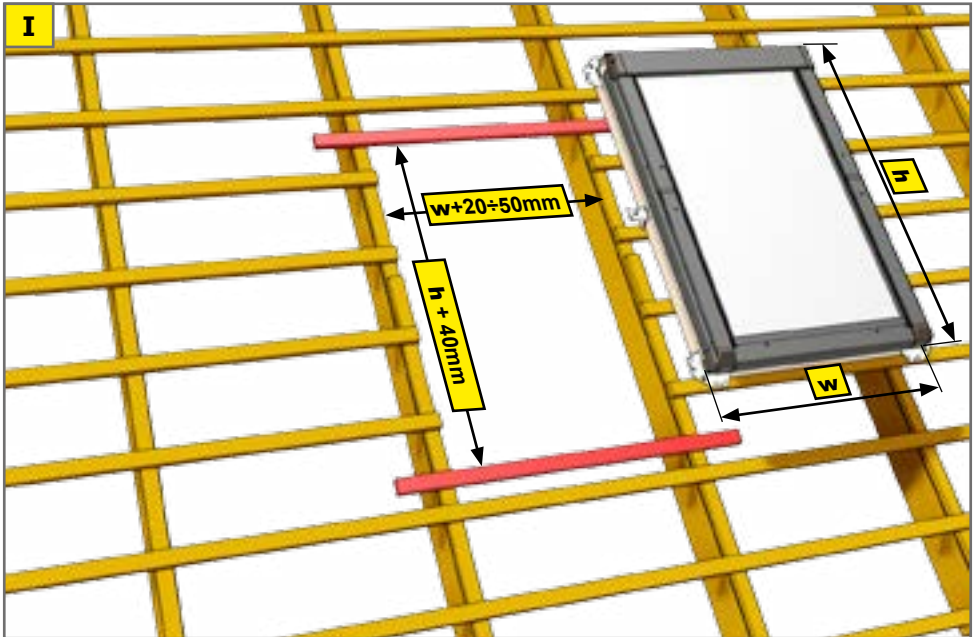
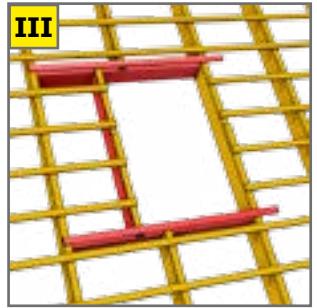
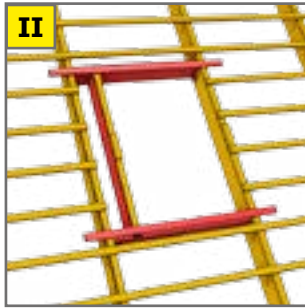
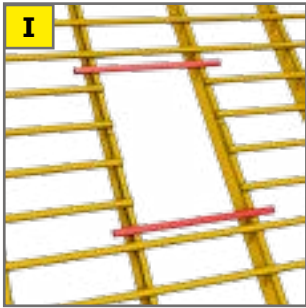

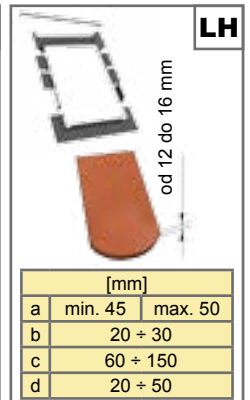
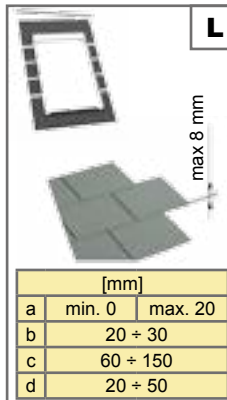
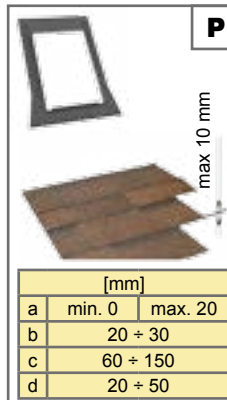
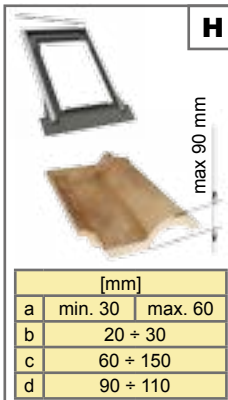
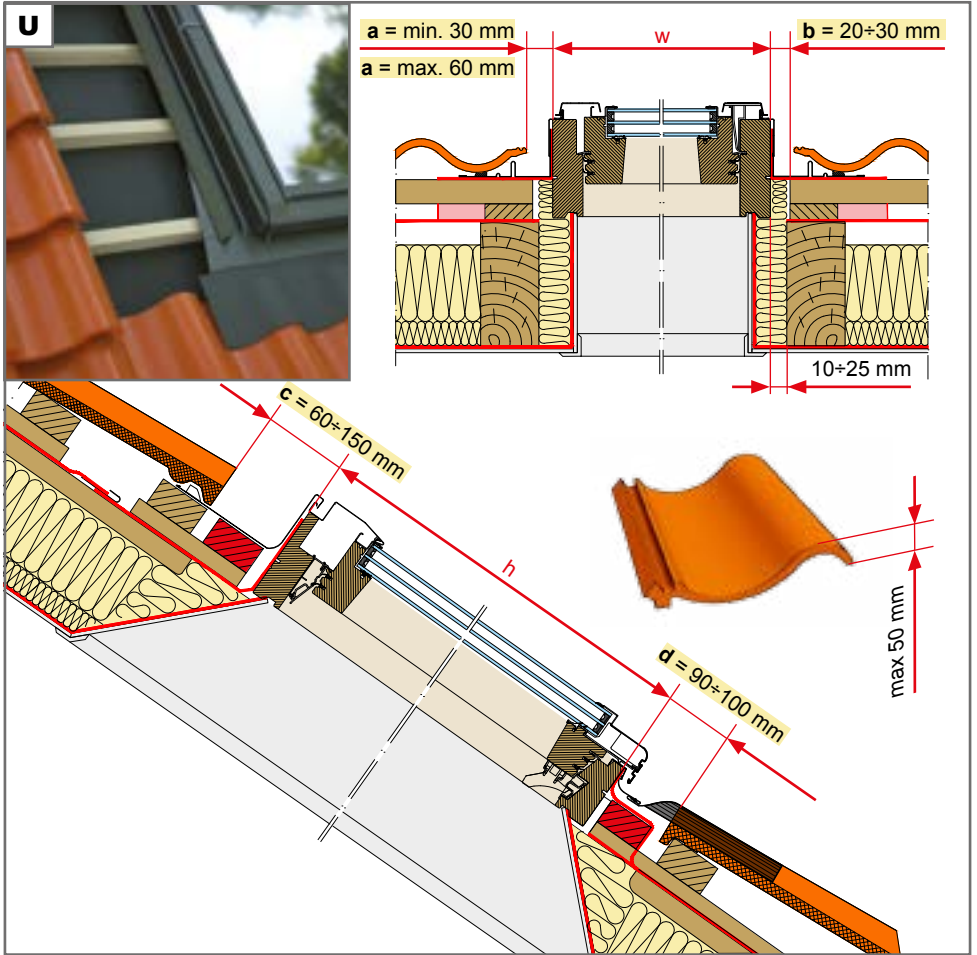

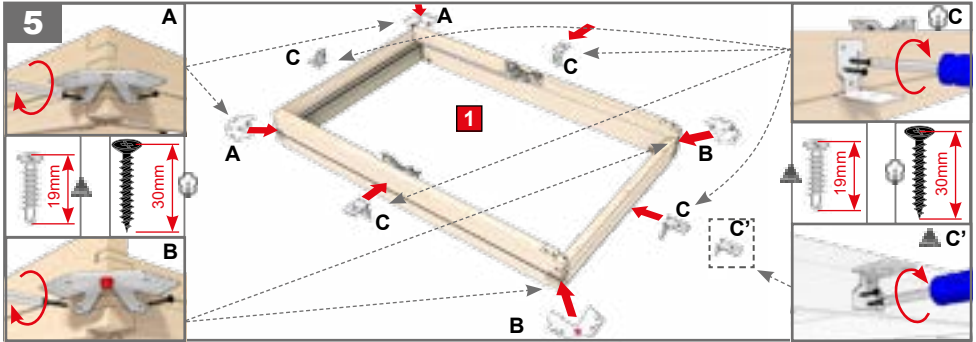
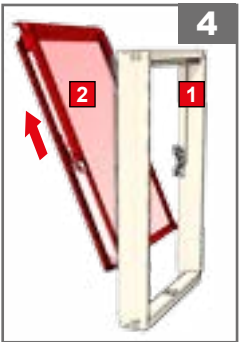
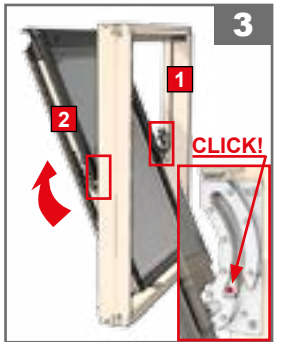
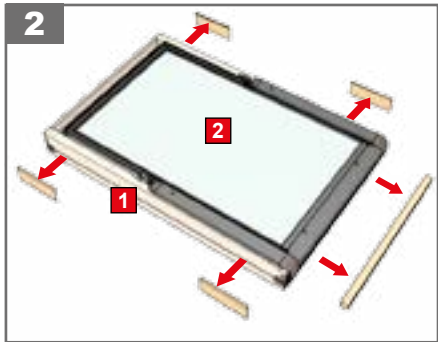
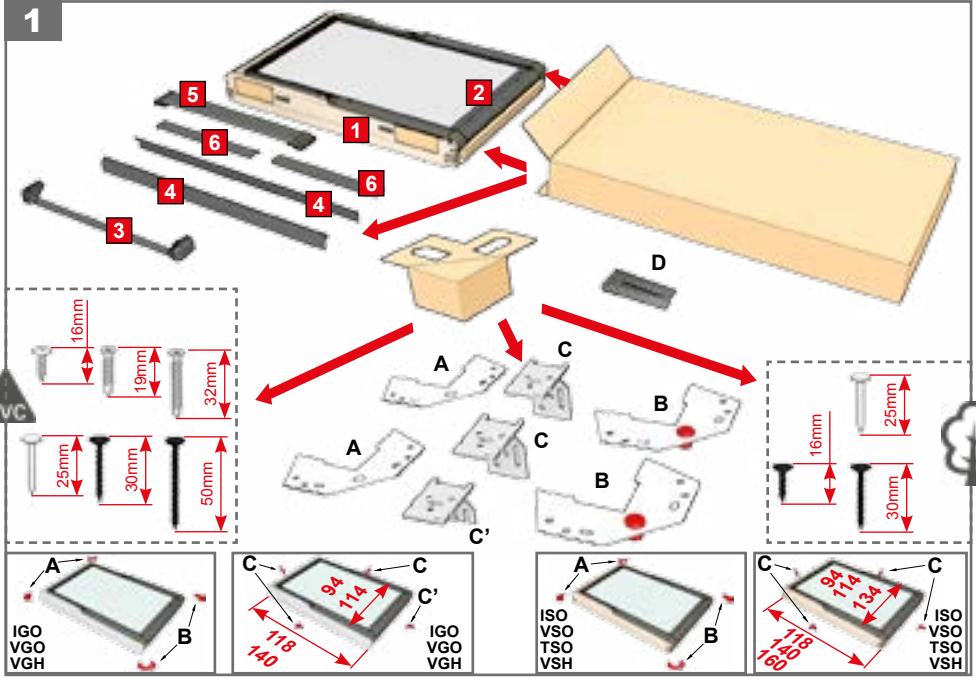

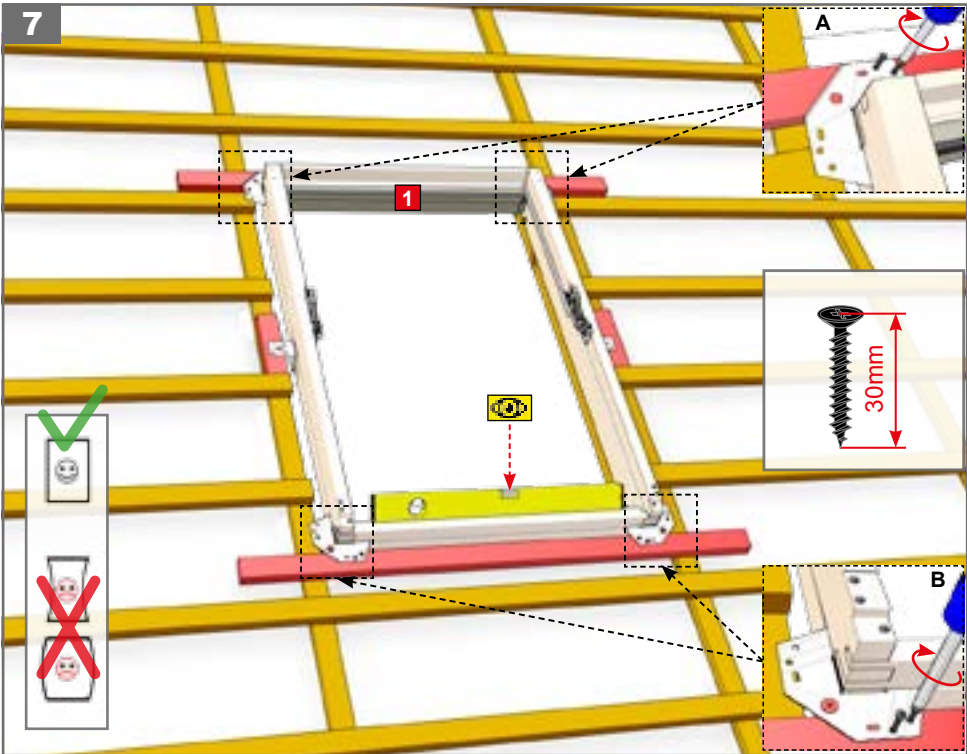
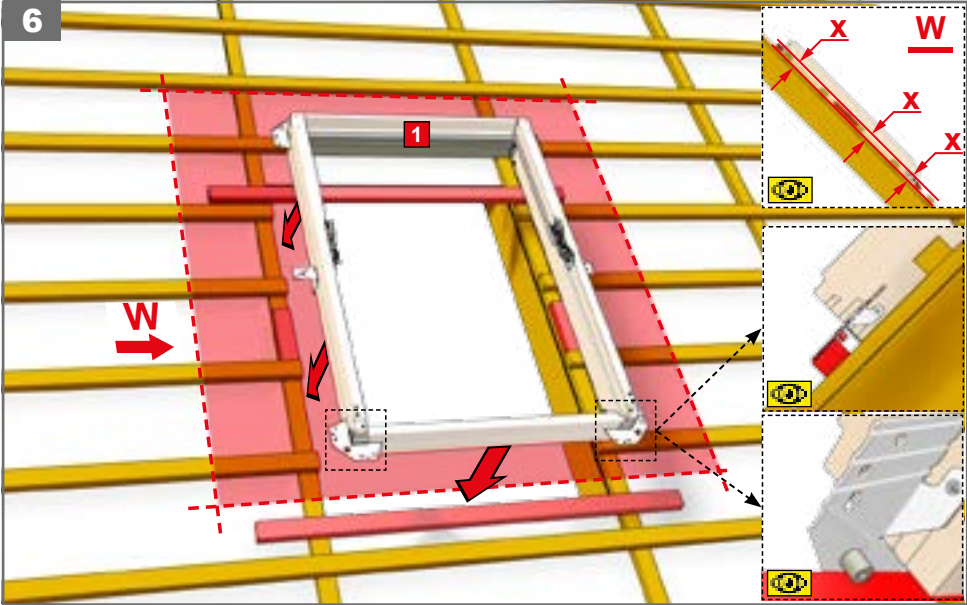

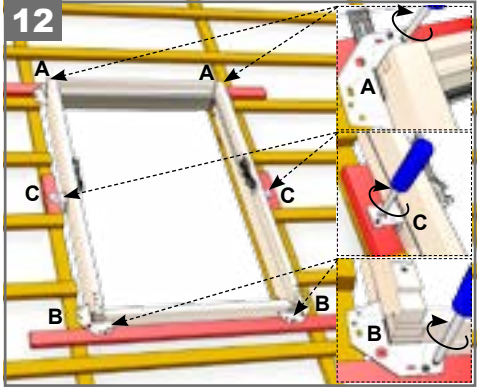
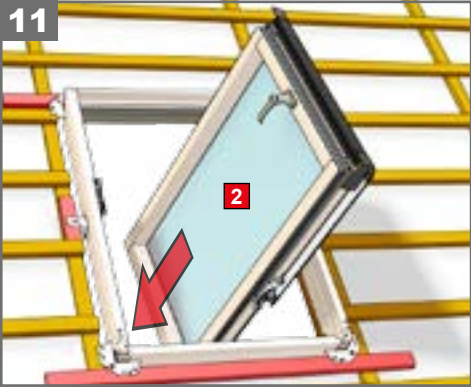
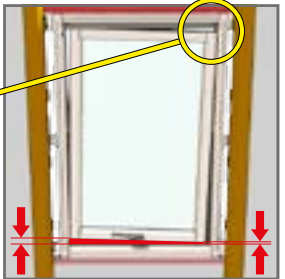
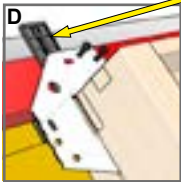
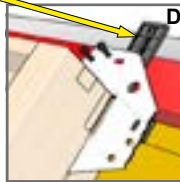
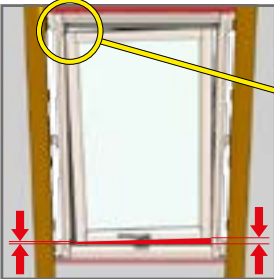
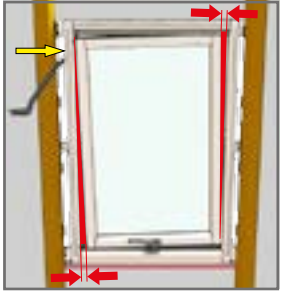
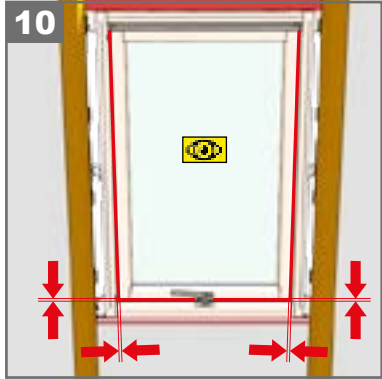
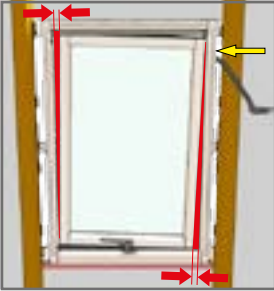
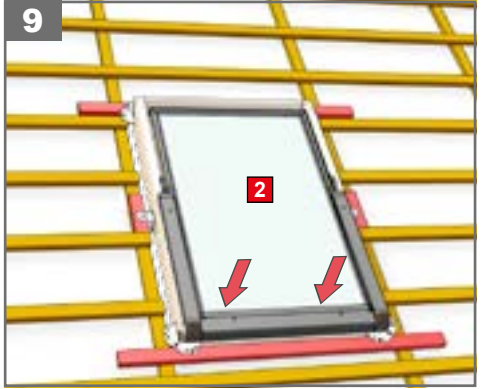
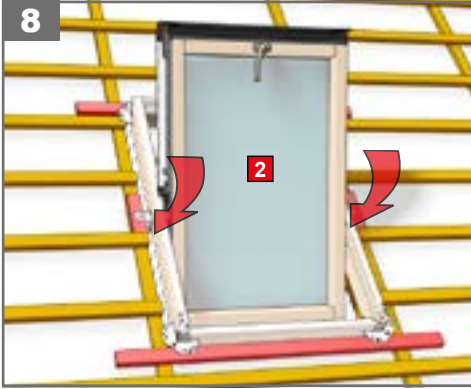

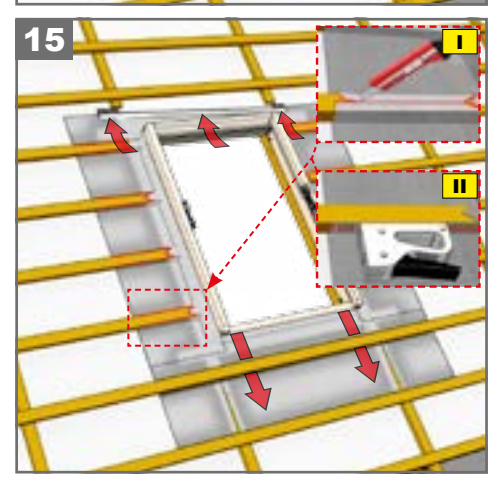
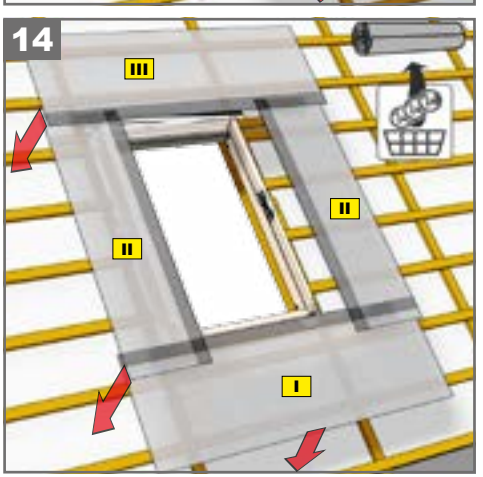
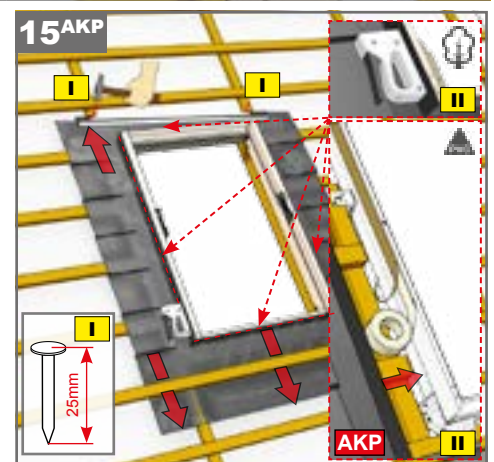
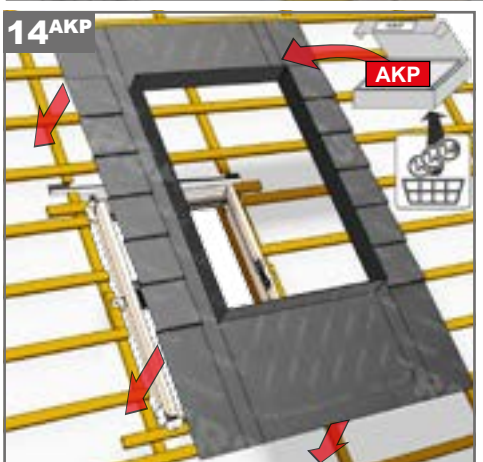
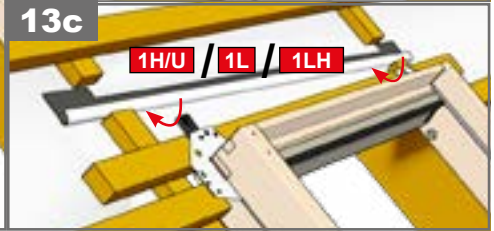
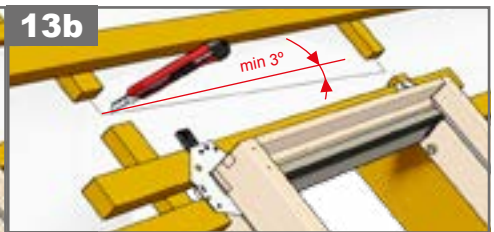
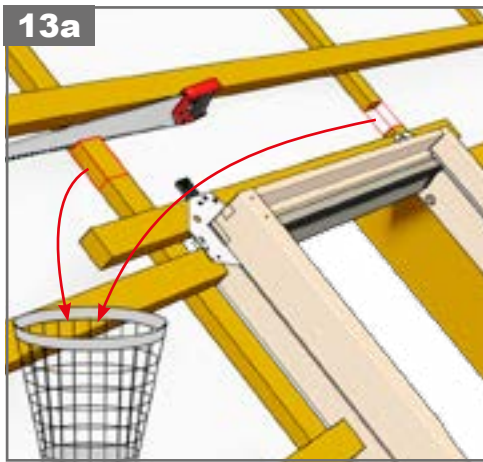

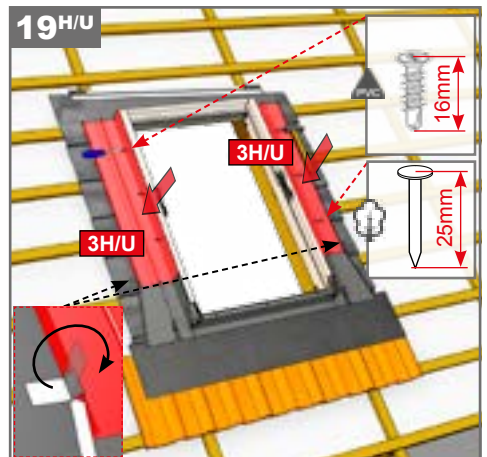
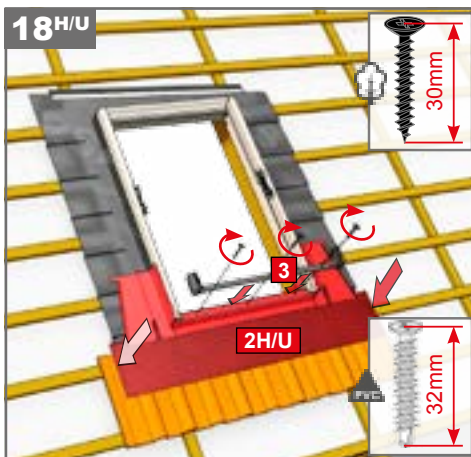
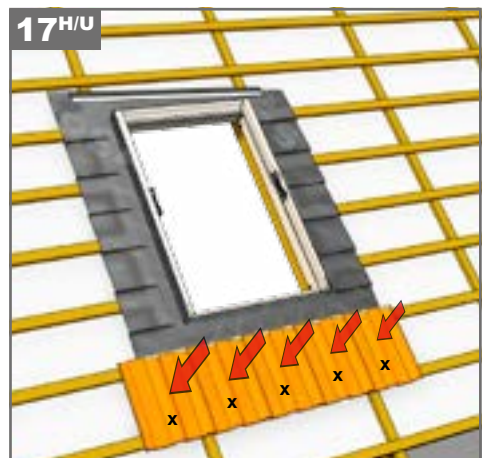
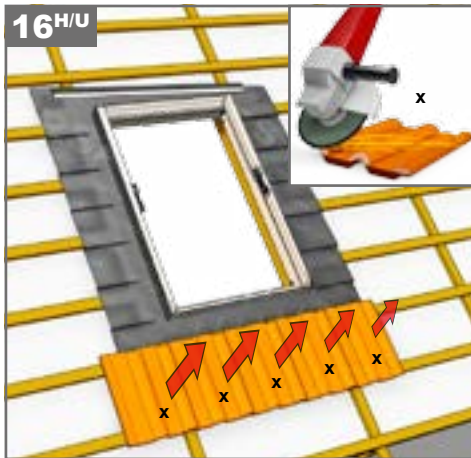
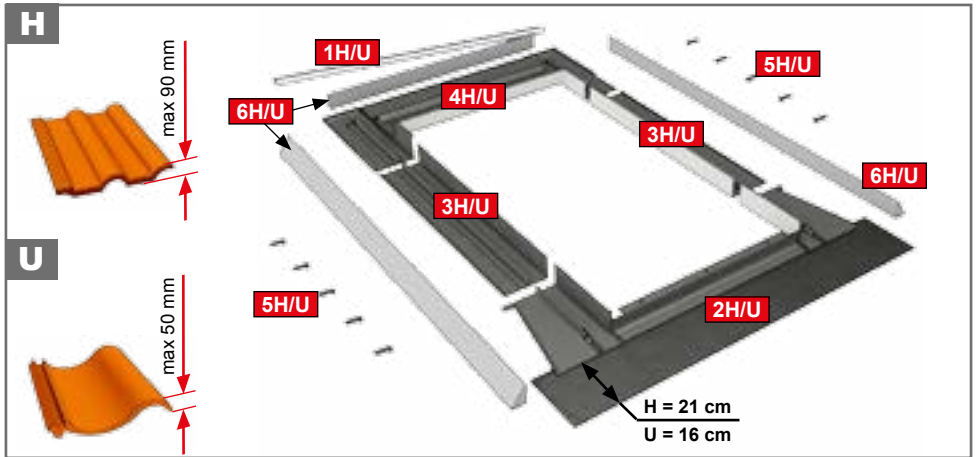

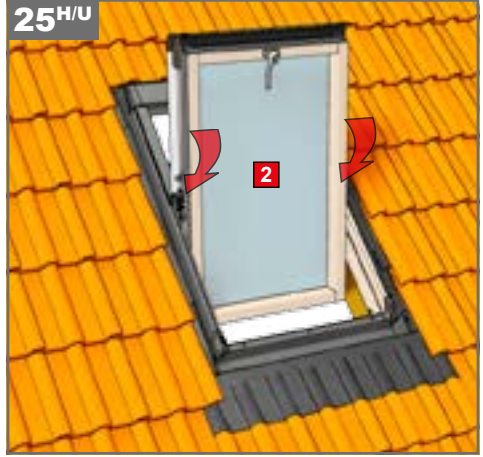
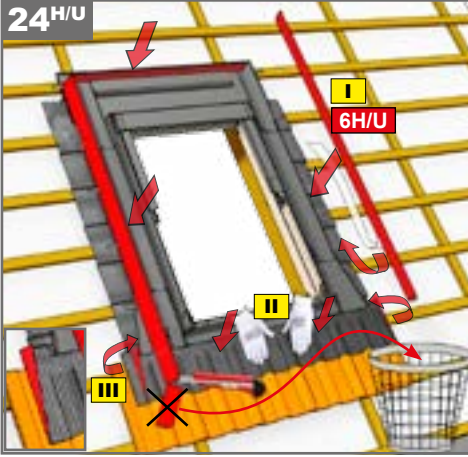
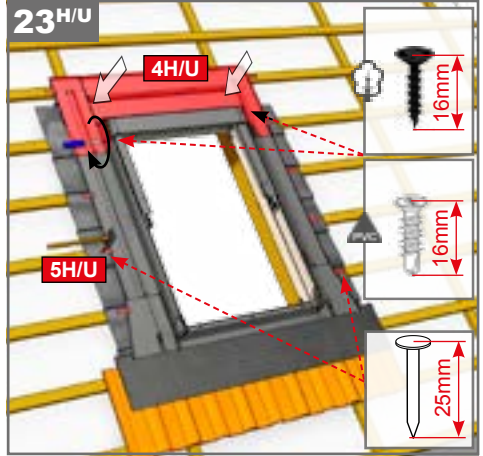
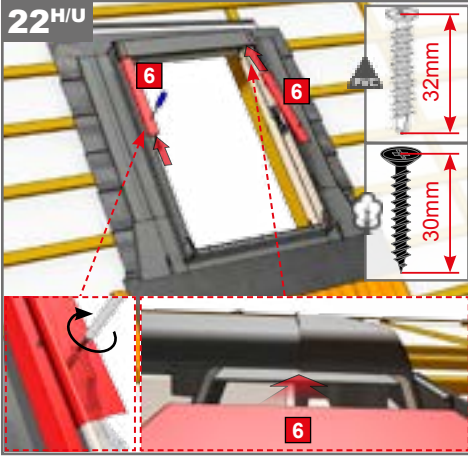
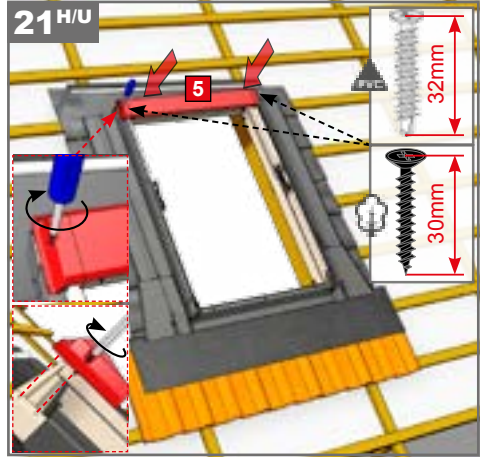
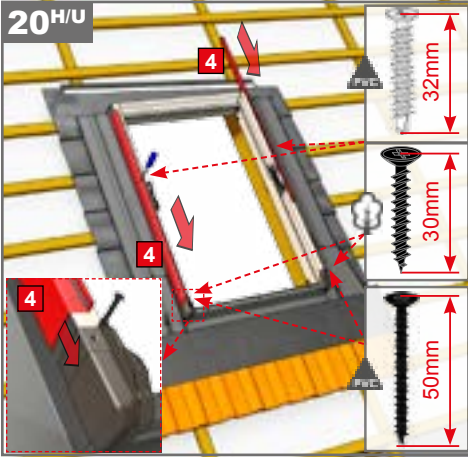

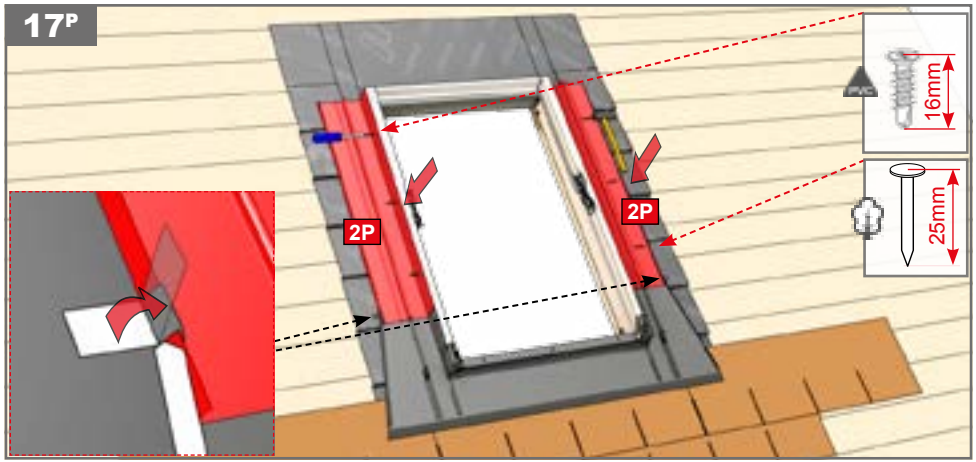
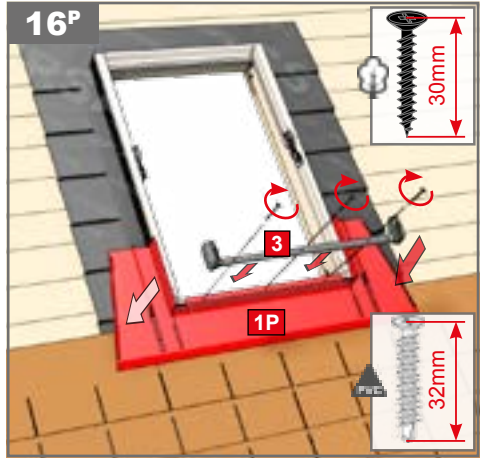
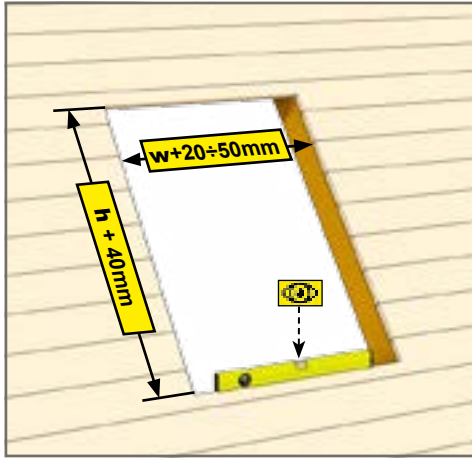
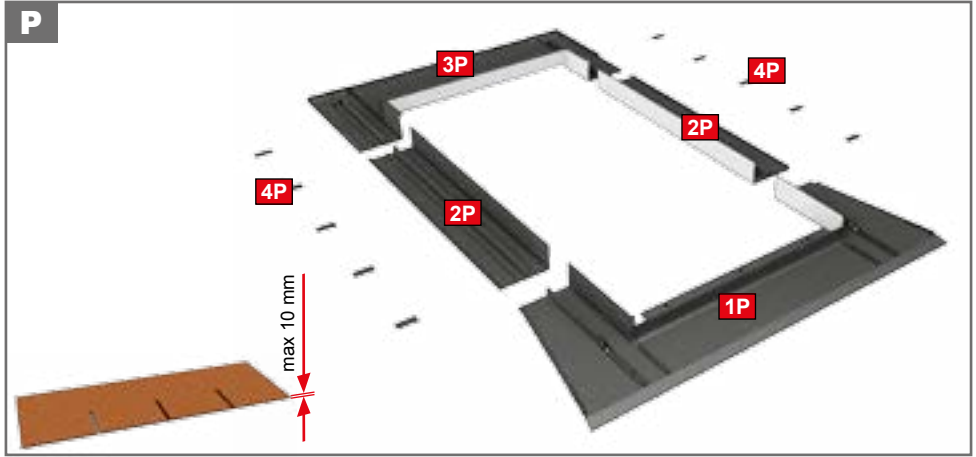

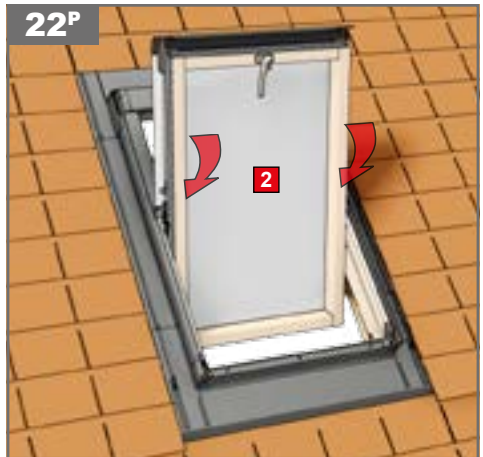
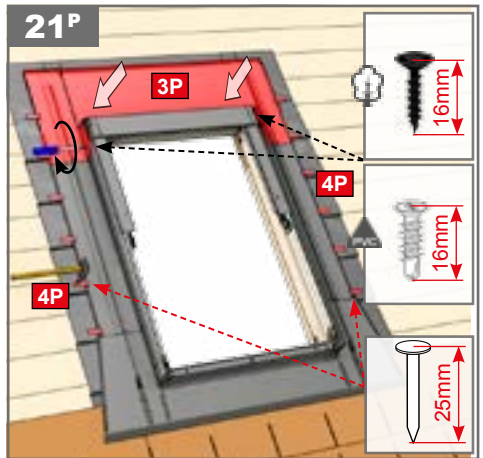
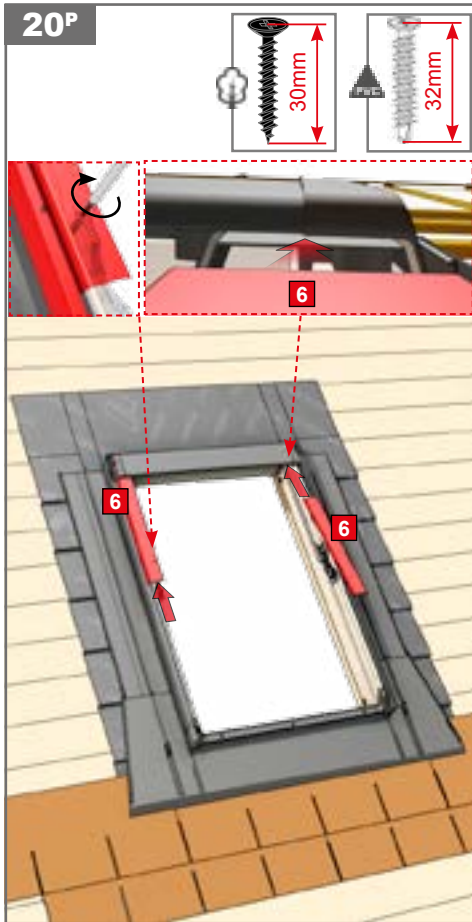
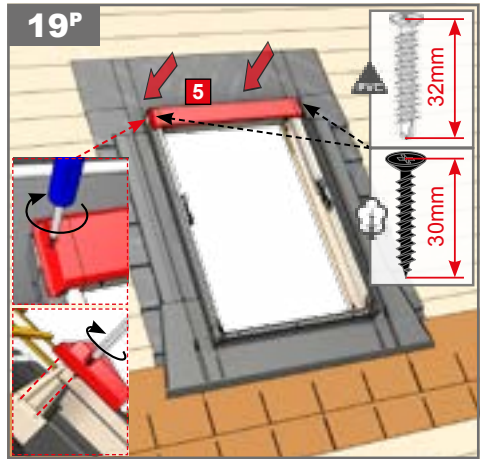
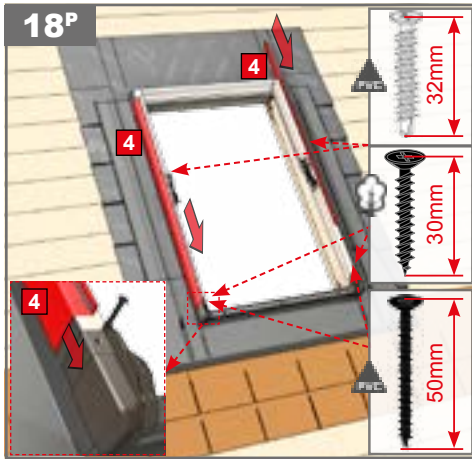

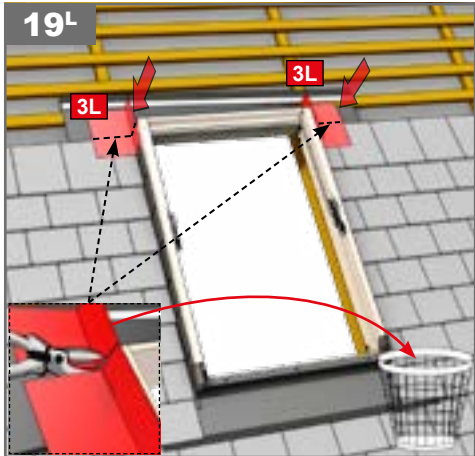
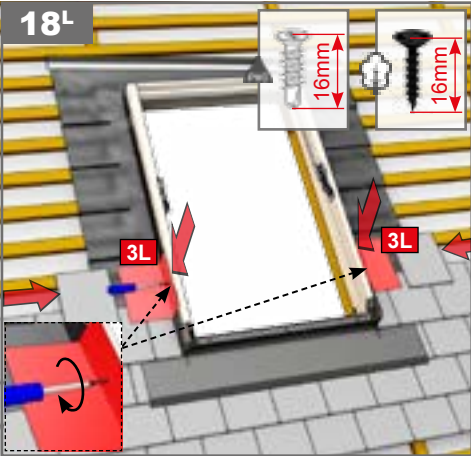
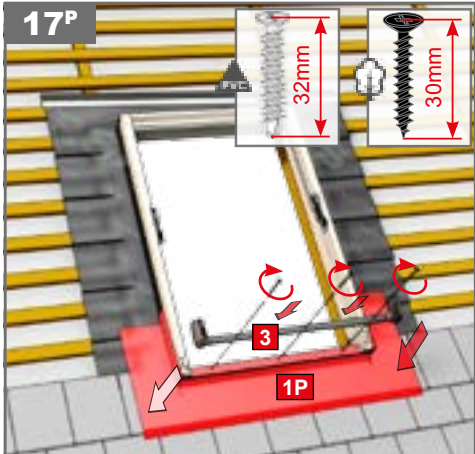
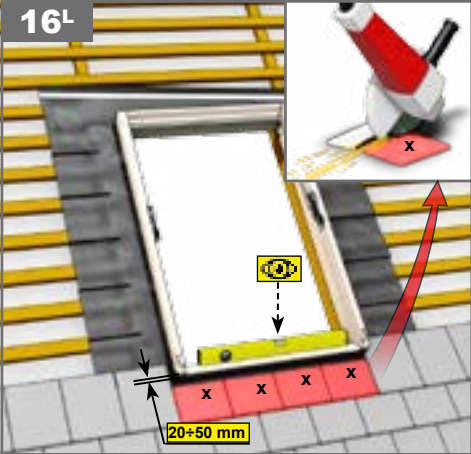
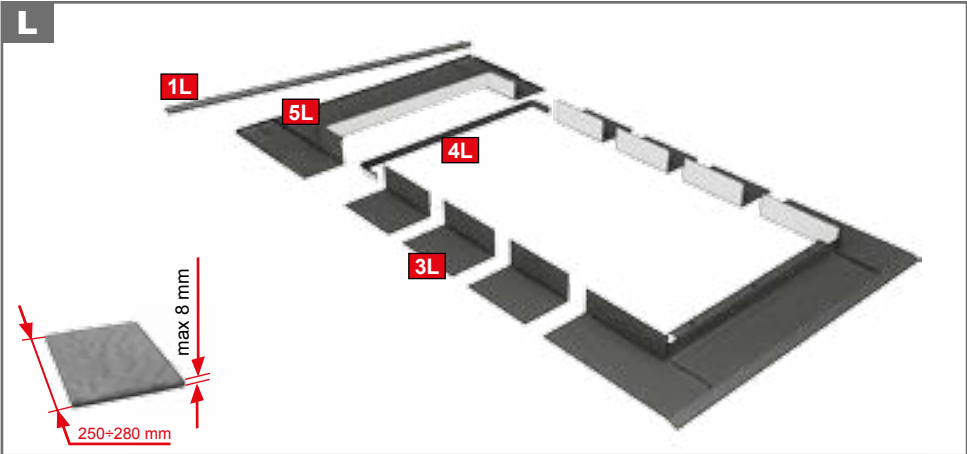

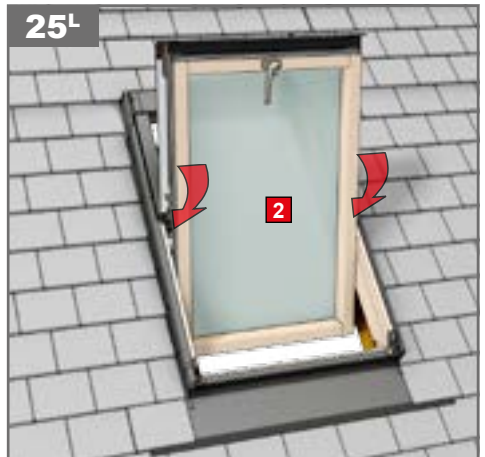
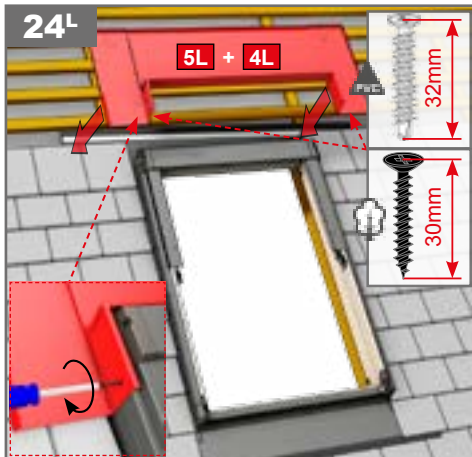
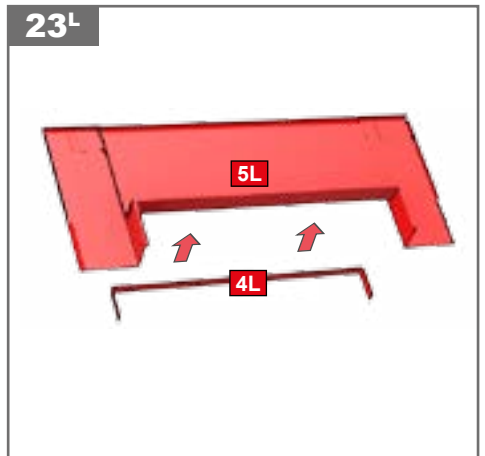
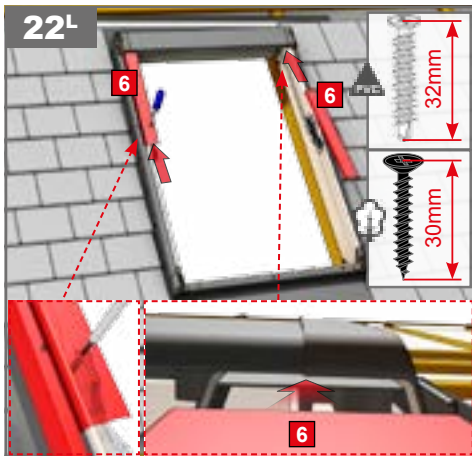
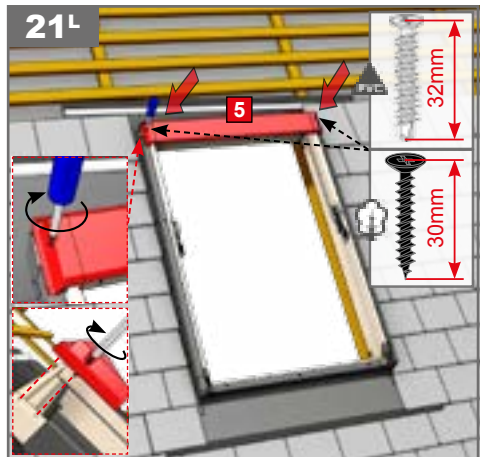
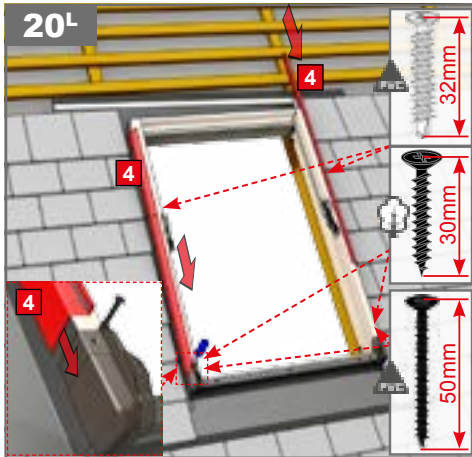

LH

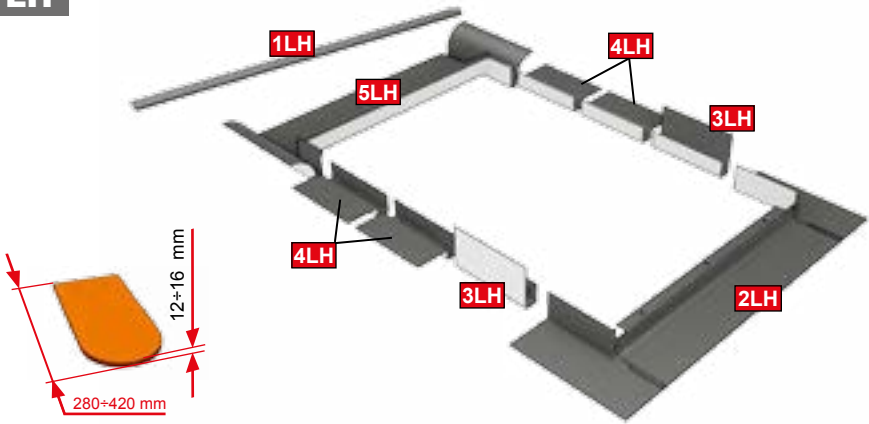

16^{LH}

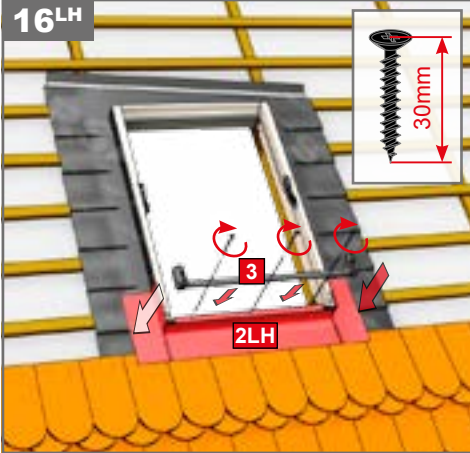

17^{LH}

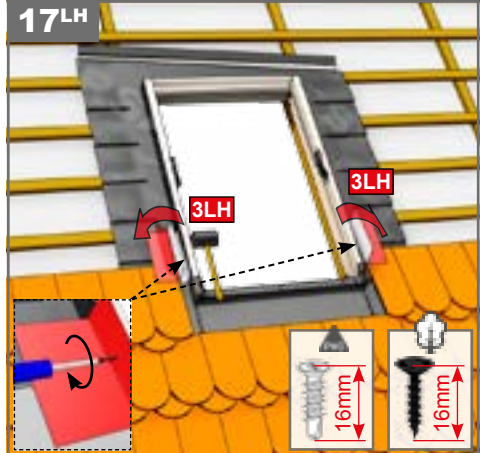

18^{LH}

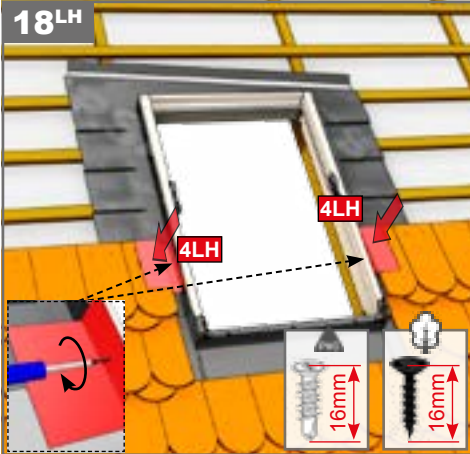

19^{LH}

